



# CRC3000 Series

Configurable Switch



## Overview

The NexLight family of Configurable Switches provides a modern aesthetic for projects that utilize the NexLight Lighting Control System. These switches enable users with advanced solutions, allowing them to easily meet the stringent sequence of operation requirements they encounter in the commercial building environment. The Alternate Function feature allows the user to define two separate control operations for a single switch and use a system address to control which is active. Programming of the Configurable Switches is achieved through the NexLight Lighting Controls App using NFC technology. These switches are designed to be easily modified with color change kits and accept standard decorator size wall plates.

## Standards Listings

**KC:**  
(R-R-JHG-CRC3068)

**FCC:**

This device complies with Part 15 of the FCC Rules. Operation is subject to the following two conditions: (1) This device may not cause harmful interference, and (2) this device must accept any interference received, including interference that may cause undesired operation.

## Features

- » Powered directly from 2-Wire Data Bus
- » NFC Programmable using NexLight Lighting Controls App
- » Interchangeable switch paddles
- » Color change options
- » Alternate Function feature
- » Local timer feature (timed on or delay off)
- » Standard decorator size opening

## Physical Specification

<b>Dimensions:</b>	4.12" H x 1.77" W x 0.74" D (105 mm x 45 mm x 19 mm)
<b>Mounting:</b>	Wall Type
<b>Temperature Rating:</b>	14 °F to 131 °F (-10 °C to 55 °C)
<b>Weight:</b>	1.63 oz (46 g)
<b>Mounting Screw Torque:</b>	3.2 lbf-in to 3.7 lbf-in (0.36 N·m to 0.42 N·m)
<b>Screw Terminal Torque:</b>	4.3 lbf-in to 5.1 lbf-in (0.49 N·m to 0.58 N·m)

## Electrical (Low Voltage)

<b>Data Input:</b>	±24 VAC, Signal
<b>Current Draw:</b>	4.4 mA



# Family Products

**CRC3061**

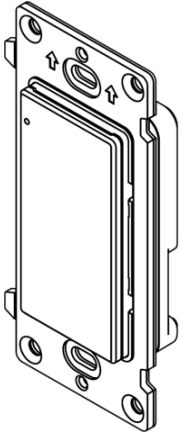

**1 Button Configurable Switch  
Color Change Kit CRC9731-XX  
(See Accessories for Color Options)**

**CRC3062**

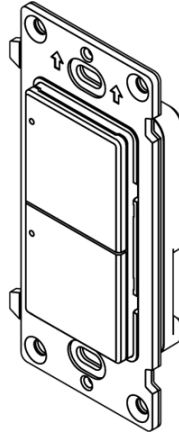

**2 Button Configurable Switch  
Color Change Kit CRC9732-XX  
(See Accessories for Color Options)**

**CRC3064**

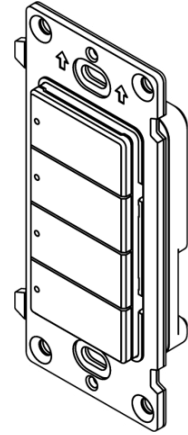

**4 Button Configurable Switch  
Color Change Kit CRC9734-XX  
(See Accessories for Color Options)**

**CRC3068**

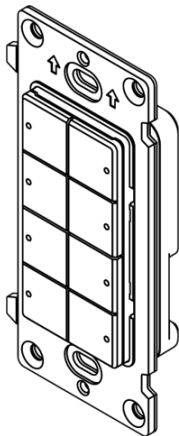

**8 Button Configurable Switch  
Color Change Kit CRC9738-XX  
(See Accessories for Color Options)**

**CRC3071**

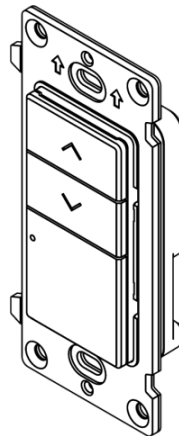

**Single Dimmer Configurable Switch  
Color Change Kit CRC9741-XX  
(See Accessories for Color Options)**

**CRC3072**

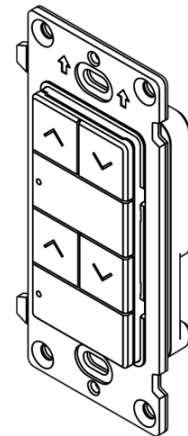

**Dual Dimmer Configurable Switch  
Color Change Kit CRC9742-XX  
(See Accessories for Color Options)**



# Accessories

Configurable Switches utilize interchangeable switch paddles. All switch paddle layouts are available in the following colors. (White-**WH**, Ivory-**IV**, Light Almond-**LA**, Gray-**GY**, Black-**BK**, Red-**RD**).

CRC9731-XX



1 Button Configurable Switch

CRC9732-XX



2 Button Configurable Switch

CRC9734-XX



4 Button Configurable Switch

CRC9738-XX



8 Button Configurable Switch

CRC9741-XX



Single Dimmer Configurable Switch

CRC9742-XX



Dual Dimmer Configurable Switch

CRC9731-WH



White

CRC9731-IV

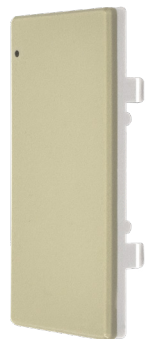

Ivory

CRC9731-LA



Light Almond

CRC9731-GY



Gray

CRC9731-BK



Black

CRC9731-RD



Red

## Terminal Identification

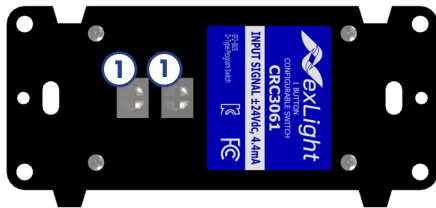

1. 2-Wire Data Bus

## Wiring Diagrams

2-Wire Data Bus, 16 AWG, non-polarized, Belden 6200UE or equivalent

Low voltage control wiring of a Configurable Switch.

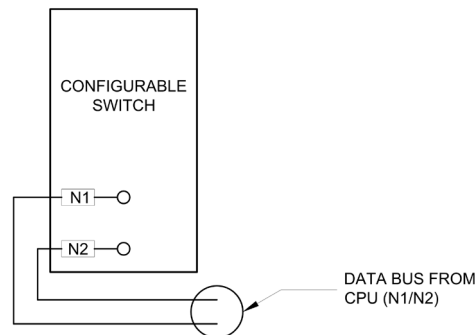

# Programming

Programming: NexLight Lighting Controls App, Smart devices with NFC Tag feature  
OS: Android (5.0 Lollipop or later), iOS (14 or later)

Google Play

App Store



## NFC Tag Location

